

UNIVERSAL STEREO PRE - AMPLIFIER

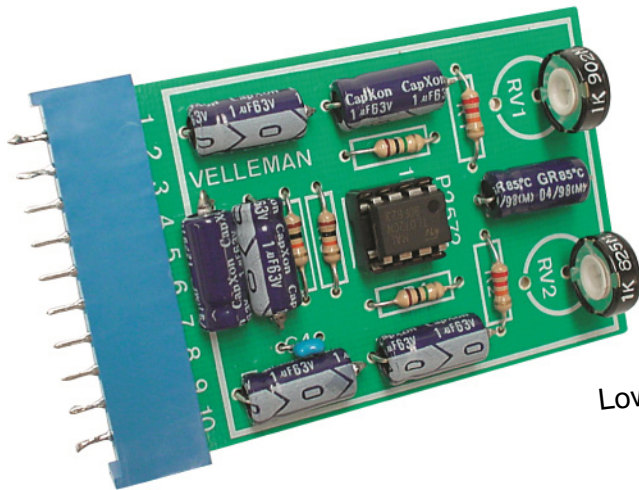

K2572

Low noise preamplifier to boost small signals.

Specifications:

- Power supply: 10 - 30V DC maximum, stabilized.
- Current absorption with out charge : typ. 5mA.
- Adjustable gain : 40dB max.
- Frequency range : 40Hz - 30KHz (-3dB).
- Output impedance : 1K Ω .
- Max. Input voltage : 50mVrms (500mVrms)
- Dimensions : 44 x 65mm / 1,7" x 2,6"

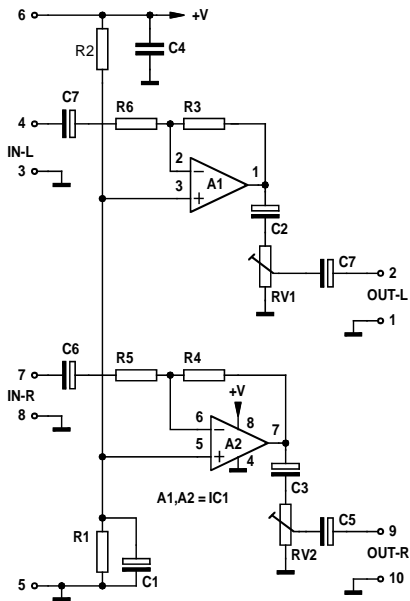

1. Assembly (Skipping this can lead to troubles !)

Ok, so we have your attention. These hints will help you to make this project successful. Read them carefully.

1.1 Make sure you have the right tools:

- A good quality soldering iron (25-40W) with a small tip.
- Wipe it often on a wet sponge or cloth, to keep it clean; then apply solder to the tip, to give it a wet look. This is called 'thinning' and will protect the tip, and enables you to make good connections. When solder rolls off the tip, it needs cleaning.
- Thin raisin-core solder. Do not use any flux or grease.
- A diagonal cutter to trim excess wires. To avoid injury when cutting excess leads, hold the lead so they cannot fly towards the eyes.
- Needle nose pliers, for bending leads, or to hold components in place.
- Small blade and Phillips screwdrivers. A basic range is fine.

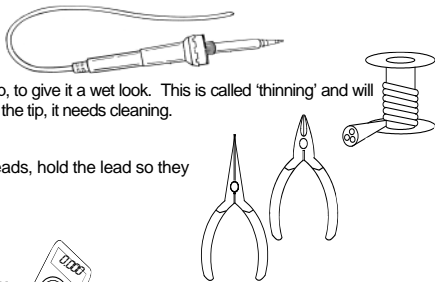

For some projects, a basic multi-meter is required, or might be handy



1.2 Assembly Hints :

- ⇒ Make sure the skill level matches your experience, to avoid disappointments.
 - ⇒ Follow the instructions carefully. Read and understand the entire step before you perform each operation.
 - ⇒ Perform the assembly in the correct order as stated in this manual
 - ⇒ Position all parts on the PCB (Printed Circuit Board) as shown on the drawings.
 - ⇒ Values on the circuit diagram are subject to changes.
 - ⇒ Values in this assembly guide are correct*
 - ⇒ Use the check-boxes to mark your progress.
 - ⇒ Please read the included information on safety and customer service
- * Typographical inaccuracies excluded. Always look for possible last minute manual updates, indicated as 'NOTE' on a separate leaflet.

1.3 Soldering Hints :

1- Mount the component against the PCB surface and carefully solder the leads

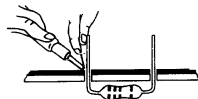

2- Make sure the solder joints are cone-shaped and shiny

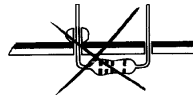
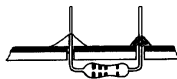

3- Trim excess leads as close as possible to the solder joint

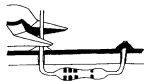

REMOVE THEM FROM THE TAPE ONE AT A TIME !

DO NOT BLINDLY FOLLOW THE ORDER OF THE COMPONENTS ONTO THE TAPE. ALWAYS CHECK THEIR VALUE ON THE PARTS LIST!

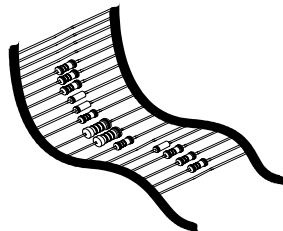

1. Resistors

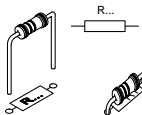

- R1 : 22K (2 - 2 - 3 - B)
- R2 : 22K (2 - 2 - 3 - B)
- R3 : 1MΩ (1 - 0 - 5 - B)
- R4 : 1MΩ (1 - 0 - 5 - B)
- R5 : 10K (1 - 0 - 3 - B)
- R6 : 10K (1 - 0 - 3 - B)

2. IC socket. Watch the position of the notch!

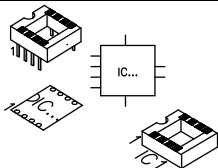

- IC1 : 8p

3. Ceramic Capacitor

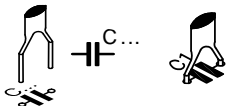

- C4 : 100nF (104, u1)

4. Electrolytic capacitors. Watch the polarity !

- C1 : 10μF
- C2 : 1μF
- C3 : 1μF
- C5 : 1μF
- C6 : 1μF
- C7 : 1μF
- C8 : 1μF

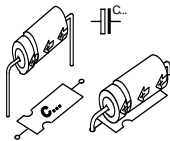

5. Potentiometers

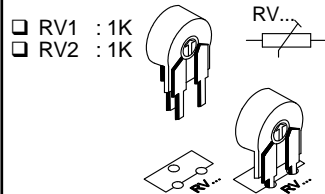

- RV1 : 1K
- RV2 : 1K

6 . IC. Watch the position of the notch!

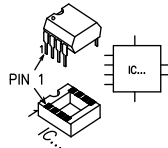

- IC1 : TL072

7. Use

Ten connections are provided on the pcb to connect the print with a device. These connections are identical to those of the RIAA preamplifier K2573 and in case you use the connectors included in this kit, you may interchange the two prints.

- | | |
|--------------------------|---------------------|
| 1. Ground | 6. + (power supply) |
| 2. Out left | 7. In right |
| 3. Ground | 8. Ground |
| 4. In left | 9. Out right |
| 5. Ground (Power supply) | 10. Ground |

The grounds near the Ins and Outs are used to connect the shielded wires (-) of the connecting leads. The output amplitude of the right and the left channel are totally independent settable by respectively RV1 & RV2. As current consumption is very low, voltage can be taken from any well stabilized power supply of 10 trough 30V DC. Lower the gain from 100 to 10 if the input signal is bigger than 50mV (500mV max), by replacing R5 & R6 by 100K resistors.



Remarks : A nonwell stabilized power supply will give a noise and hum. The leads, from and to the print, must be as short as possible and make use of shielded wires only. Never place the preamp in the vicinity of transformers or net.

8. PCB

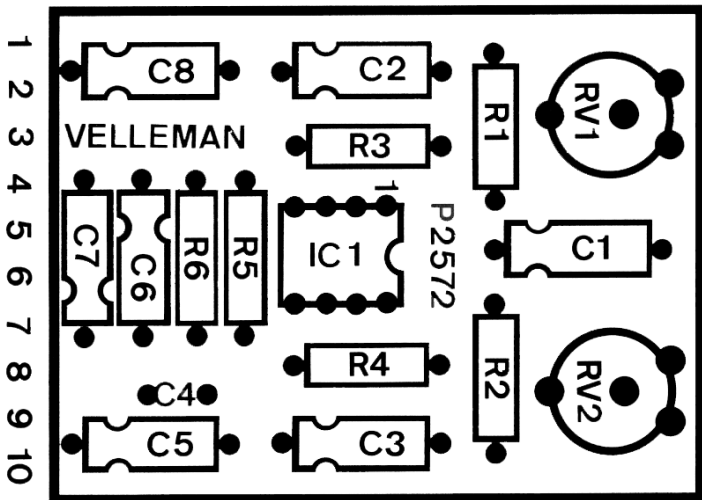

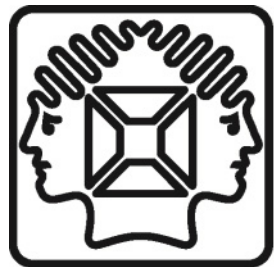

VELLEMAN NV
Legen Heirweg 33, B-9890 GAVERE
Belgium (Europe)

